

# GRUNDIG

## Hood

User Manual

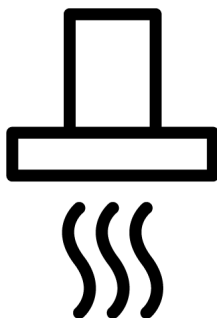

GDSP2474BBSC

185732210/ EN/ R.AA/ 26/04/2022 10:56  
7704331112



## **Table of Contents**

---

<b>1</b>	<b>Safety Instructions .....</b>	<b>4</b>
1.1	General Safety .....	4
1.2	Electrical Safety .....	5
1.3	Product Safety.....	6
1.4	Intended Use .....	8
1.5	Child, Vulnerable Persons and Pet Safety.....	8
1.6	Transportation Safety .....	9
<b>2</b>	<b>Environmental Instructions .....</b>	<b>9</b>
2.1	Waste Directive.....	9
2.1.1	Compliance with the WEEE Dir- ective and Disposing of the Waste Product.....	9
2.2	Package Information.....	9
<b>3</b>	<b>Your product.....</b>	<b>10</b>
3.1	Product Introduction.....	10
3.2	Product Accessories.....	10
3.3	Technical Specifications .....	12
<b>4</b>	<b>Using the Hood.....</b>	<b>13</b>
<b>5</b>	<b>Maintenance and Cleaning .....</b>	<b>16</b>
5.1	General Cleaning Information.....	16
5.2	Aluminium Filter .....	16
5.3	Hood Lamp .....	17
5.4	Carbon Filter (Usage without a flue) .....	17
<b>6</b>	<b>Troubleshooting .....</b>	<b>17</b>

---

## Welcome!

---

Dear Customer,

Thank you for choosing the Grundig product. We want your product, manufactured with high quality and technology, to offer you the best efficiency. Therefore, carefully read this manual and any other documentation provided before using the product.

Keep in mind all the information and warnings stated in the user's manual. This way, you will protect yourself and your product against the dangers that may occur.

Keep the user's manual. If you give the product to someone else, give the manual with it. The warranty conditions, usage and troubleshooting methods for your product are provided in this manual.

### The symbols and their descriptions in the user's manual:



Hazard that may result in death or injury.



Important information or useful usage tips.



Read the user's manual.



Hot surface warning.

**NOTICE** Hazard that may result in material damage to the product or its environment.

**Arçelik A.Ş.**

Karaağaç caddesi No:2-6  
34445 Söğütözü/İstanbul/TURKEY

Made in TURKEY



## 1 Safety Instructions

---

- This section includes the safety instructions necessary to prevent the risk of personal injury or material damage.
- If the product is handed over to someone else for personal use or second-hand use purposes, the user's manual, product labels and other relevant documents and parts should also be given.
- Our company shall not be held responsible for damages that may occur if these instructions are not observed.
- Failure to follow these instructions shall void any warranty.
- Always have the installation and repair works made by the manufacturer, the authorised service or a person that the importer company shall designate.
- Use original spare parts and accessories only.
- Do not repair or replace any component of the product unless it is clearly specified in the user's manual.
- Do not make technical modifications on the product.



### 1.1 General Safety

- This product can be used by children 8 years of age and older, and people who are underdeveloped in physical, sensory or mental skills, or who have lack of experience and knowledge, as long as they are supervised or trained about the safe use and hazards of the product. Children should not play with the appliance. Cleaning and user maintenance must not be made by children without supervision.
- **Poisoning Danger!** While the appliance is operating, air is drawn from the whole house. If adequate ventilation is not provided, air flow occurs and the waste and toxic gases released as a result of combustion in the house are reabsorbed. Do not operate the product together with products that provide air circulation and may emit toxic gas (wood, gas, oil and coal stoves, boilers, water heaters, etc.).

- Have the adequacy of your building's ventilation and flue system checked by authorized persons.
- This product is not intended for use by persons (including children) with limited physical, sensory or mental capacity or without knowledge or experience, unless supervised or instructed by the individual responsible for their safety. Children should be supervised to ensure that they do not play with the product. Cleaning and user maintenance must not be made by children without supervision.
- Installation and repair procedures must always be performed by **Authorised Service Agents**. The manufacturer cannot be held responsible for any damages that may arise due to operations made by unauthorized persons.
- Do not operate the product if it is defective or has any visible damage.
- Ensure that the product function knobs are switched off after every use.
- If the product is handed over to someone else for personal use or second-hand use purposes, the user's manual, product labels and other relevant documents and parts should also be given.
- Call the authorized service for the installation of the product to be used. The warranty term starts after this process.
- Product must be installed by a qualified person in accordance with the regulations in force for the warranty to be applicable.



## 1.2 Electrical Safety

- To have your product ready for use, first provide the place of installation and have the electrical installation made. Then, call the nearest Authorised Service.
- If the product has a failure, it should not be operated unless it is repaired by an Authorised Service Agent. There is the risk of electric shock!
- Do not plug your hood in until it is mounted.
- If your product has plug, never touch the plug with wet hands! Never unplug by pulling on the cable, always pull out by holding the plug.

- The appliance power should be cut off during installation, maintenance, cleaning and repair processes.
- In order to prevent any hazard from occurring, in case of damage, the electrical cable must be replaced by the manufacturer, the manufacturer's service centre or a similar qualified person.
- If the cable is damaged, contact our nearest service centre and have a new one installed.
- If your product has plug, do not make electrical connections by disconnecting the plug during installation. Connections made by cutting off render the product warranty void and pose a danger to user safety.
- Do not install the mains cord near the heaters. The cable might melt, causing a fire.
- If your product does not have a cable, only use the connecting cable described in the "Technical specifications" section.
- Any work on electrical equipment and systems should only be carried out by authorised and qualified persons.
- In case of any damage, switch off the product and disconnect it from the mains. To do this, turn off the fuse at home.
- Make sure that fuse rating is compatible with the product.
- Never wash the appliance by spraying or pouring water on it! There is the risk of electric shock!



### **1.3 Product Safety**

- Height between the bottom surface of your hood and the top surface of the oven should be no less than 650 mm for gas ovens and 500 mm for electrical ovens.
- (For Model C) In electrical ovens, the highest performance in the product is achieved by leaving a height of 550 mm.
- Do not touch the lamps of your hood after operating the hood for a long time. Hot lamps may burn your hand.
- Do not operate the appliance without an oil entrapment filter. Do not remove the filters while the appliance is operating.

- Do not create a high flame under the product. Otherwise, the oil in the oil trap filter may ignite, causing a fire.
- Run the product after placing the cooking pots, pans, etc. on the ovens. Otherwise, rising heat may deform some parts of your product.
- Turn off the oven before taking the cooking pots, pans, etc. from the ovens.
- Do not keep easily flammable materials under your hood.
- Do not expose the appliance to open flame. It may cause the oil accumulating in the filter to catch fire. Do not operate the appliance without a filter.
- Do not leave your cooker unattended while cooking fried foods, oils may catch fire while cooking, and hot oil may cause fire. Therefore pay attention to the clothes and curtains.
- If cleaning is not performed in a timely manner, the hood may present a risk of fire.
- (For Models A and B) Run your hood for another 15 minutes after the cooking or frying process to clean the kitchen air thoroughly of the odours and vapours generated during cooking.
- Adequate ventilation must be available in the room when gas or other fuel-burning appliances are used at the same time while the oven hood with a cooker is being used. (Not applicable for only the appliances that discharge air back into the room).
- Gas or fuel oil burning appliances, such as room heaters, which share the same environment with the hood, must be fully insulated from the exhaust of this product or they must be hermetical.
- If there is another appliance operating with fuel oil or gaseous fuels in the environment, adequate ventilation of the environment is required.
- If there is another appliance operating with energy other than electrical energy in the same environment with the hood, the negative pressure in the room should be at most 0.04 mbar so that the exhaust of the other appliance is not drawn back into the room by the hood.

- Do not connect to flues with heating stove connection, flues where waste gas is disposed from or flues with rising flames. Comply with local regulations on purging the out-flow.
- Use pipes with a diameter of 120 mm when connecting a flue to your product. The pipe connection should be as short as possible and with few bends.
- Easily flammable and combustible materials should not be hung on the hood handles.
- Our company shall not be responsible for problems that arise for not observing any of the warnings above.
- There is a risk of fire if cleaning is not carried out in accordance with the instructions.
- There should not be open fire under the hood. (for example: flambe)
- **Caution:** Accessible parts can heat up when used with a cooker.
- It is recommended to clean the filter once a month under normal usage.



#### 1.4 Intended Use

- This product is designed for home use. Commercial use will void the guarantee.
- The manufacturer assumes no responsibility for any damage due to misuse or mishandling.
- The service life of the product you have purchased is 10 years. Manufacturer shall provide the required spare parts for the product to perform as defined during this period.



#### 1.5 Child, Vulnerable Persons and Pet Safety

- Keep children away from the product when it is running.
- Children should not play with the product. Cleaning and user maintenance should not be performed by children unless there is someone overseeing them.
- This product should not be used by people with limited physical, sensory or mental capacity (including children), unless they are kept under supervision or receive the necessary instructions.



- The packaging materials are dangerous for children. Keep the packaging materials out of the reach of children or sort them into waste according to waste instructions.
- Electrical products are dangerous for children and pets. Keep children away from the product while it is operated and do not let them play with the product.



## 1.6 Transportation Safety

- Disconnect the product from the mains before transporting the product.

- Do not put other items on the product and carry the product upright.
- When you need to transport the product, wrap it with bubble wrap packaging material or thick cardboard and tape it tightly. Secure the product tightly with tape to prevent the removable or moving parts of the product and the product from getting damaged.
- Check the overall appearance of the product for any damage that may have occurred during transportation.

## 2 Environmental Instructions

### 2.1 Waste Directive

#### 2.1.1 Compliance with the WEEE Directive and Disposing of the Waste Product

This product complies with EU WEEE Directive (2012/19/EU). This product bears a classification symbol for waste electrical and electronic equipment (WEEE).



This product has been manufactured with high quality parts and materials which can be reused and are suitable for recycling. Therefore, do not dispose of the waste product with normal domestic and other wastes

at the end of its service life. Take it to a collection point for the recycling of electrical and electronic equipment. You can ask your

local administration about these collection points. Disposing of the appliance properly helps prevent negative consequences for the environment and human health.

#### Compliance with RoHS Directive:

The product you have purchased complies with EU RoHS Directive (2011/65/EU). It does not contain harmful and prohibited materials specified in the Directive.

### 2.2 Package Information

Packaging materials of the product are manufactured from recyclable materials in accordance with our National Environment Regulations. Do not dispose of the packaging waste with the household or other wastes, take it to the packaging material collection points designated by the local authorities.

## 3 Your product

### 3.1 Product Introduction

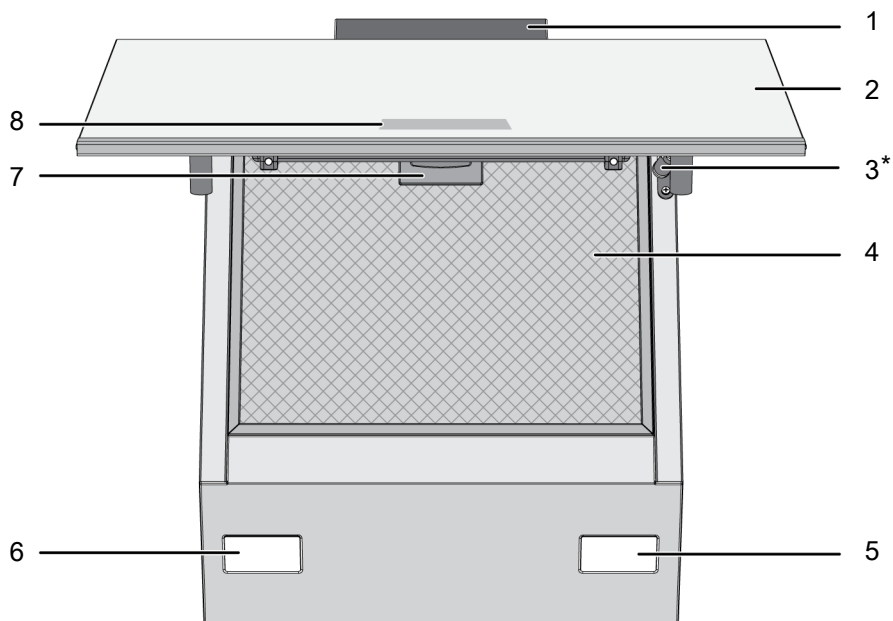

1 Hood body

3 Damper

5 Lamp

7 Aluminium filter lock

2 Hood glass lid

4 Aluminium filter

6 Lamp

8 Control panel

\* Dependent on the model. It may not be available on your product.

### 3.2 Product Accessories

Depending on the product model, the supplied accessory varies. All accessories described in the user's manual may not be available in your product.

#### Wall mounting part

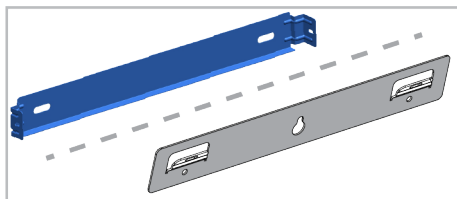

**Air router**

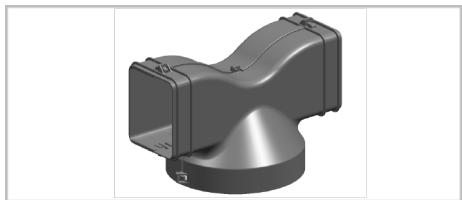

**Covers to prevent reverse airflow**

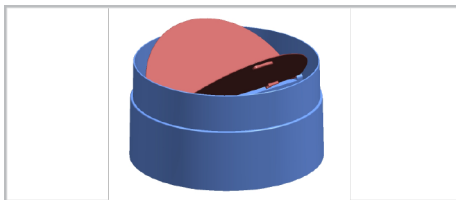

**Flue connection adapter**

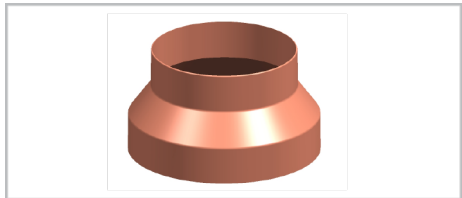

### 3.3 Technical Specifications

Product external dimensions (height/width/depth) (mm)	min. 910 - max. 1138 /595 /419
Voltage/Frequency	220-240 V ~1N; 50 Hz
Total power consumption	max. 300 W
Suction power	700-720 m <sup>3</sup> /h
Diameter of air outlet pipe	120-150 mm

Control	
Model A	3 levels
Model B	3 levels + 1 booster
Model C	3 levels + 1 booster



Technical specifications may be changed without prior notice to improve the quality of the product.



Figures in this manual are schematic and may not exactly match your product.



Values stated on the product labels or in the documentation accompanying it are obtained in laboratory conditions in accordance with relevant standards. Depending on operational and environmental conditions of the product, these values may vary.

## 4 Using the Hood

The hood has an engine with various speeds. For a good performance, we recommend using low speeds under normal conditions and high speeds in case of strong odour and vapour condensation.



The program is cancelled if power is cut when any programs in your hood are active.

### MODEL A

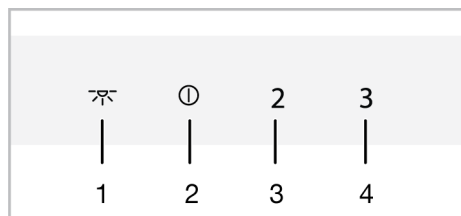

- 1 Lamp key
- 2 On-Off/Speed 1 key
- 3 Speed 2 key
- 4 Speed 3 key

### MODEL B

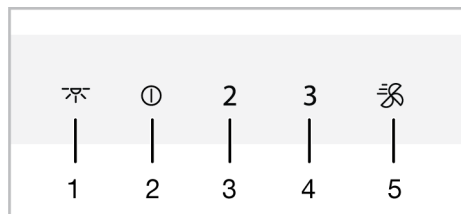

- 1 Lamp key
- 2 On-Off/Speed 1 key
- 3 Speed 2 key
- 4 Speed 3 key
- 5 Booster key

### MODEL C

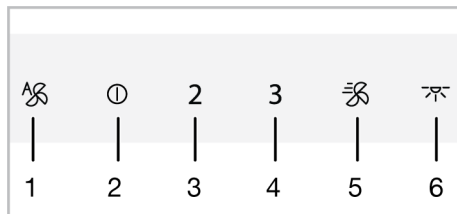

- 1 Automatic mode key
- 2 On-Off/Speed 1 key
- 3 Speed 2 key
- 4 Speed 3 key
- 5 Booster key
- 6 Lamp key

### Operating the hood

- Touch the speed level key you have selected to operate the hood.  
⇒ The set speed level key lights up.
- You can touch the other speed level keys to change the speed level.



When in operation, the product will run for a maximum of 6 hours if no key is touched.

### Turning off the hood

- To turn the hood off, touch again the key of the level on which the hood is operating or the power key.



If you touch the power key with any function active except the lamp, then the function is cancelled.



### Turning on the intensive ventilation mode (Booster) (for models B and C)

- Press the booster key once to start the hood in the intensive ventilation mode.  
⇒ The intensive ventilation mode starts up and runs for a maximum of 10 minutes. During this time, the booster key lights up. After 10 minutes, the product continues to operate in Speed 3 and the Speed 3 key lights up.



In intensive ventilation mode, when any speed key is touched, it returns to that speed level and continues to operate.

### Operating the lamp

- a. Touch the  key to operate the lamp.
  - ⇒ Hood lamp lights. (For Models B and C) If you touch the  key again within the first 1 minute, the lamp will continue to light at the low illumination level. If you touch it again 1 minute after turning the lamp on, it turns off.



The illumination lamps operate for a maximum of 12 hours.

### Turning off the lamp



- a. One minute after turning the hood lamp on, you can turn it off by touching the  key again.



(For Models B and C) If you touch the  key again within the first 1 minute after the lamp is switched on, the lamp switches to the low illumination level.

### Setting the lamp illumination colour (for models B and C)

You can use the colour of your hood's illumination lamps in 3 different shades.

- a. With the hood lamp turned on, touch  key for more than 2 seconds.
  - ⇒ The lamp changes to the other colour shade.
- b. If you continue to touch  key, it will change to the next colour shade after every 2 seconds. According to the desired colour shade, stop touching  key when the lamp is in that colour shade. The colour shade will automatically activate.



You can only change the light colour shade while the lamp has high light intensity.



In the event of a power outage, your hood will remember the colour shade set and the lamp will work in the colour that was last set.

### Automatic mode (for model C)

Your hood measures the temperature of the air in the kitchen and the air coming from your hob by using a sensor. In automatic mode, it determines the required levels for the temperature of the air from the hob to match the temperature of the air in the kitchen and operates at levels determined automatically.

- a. To enable automatic mode touch the  key.
  - ⇒ The automatic mode is activated and operates until the temperature of the air from the hob equals the ambient temperature. The temperature will switch off automatically when it equalizes. You must enable automatic mode again to re-switch it on.





While automatic mode is active, automatic mode will be cancelled when you turn the product on and off at any speed.

- b. To turn automatic mode off early touch the  key once more.



If you open the cover of the product when auto mode is on, its performance will decrease. Do not open the cover when the automatic mode is active.

 If the ambient temperature difference occurs even when the hob is not operating while the automatic mode is active, the temperature sensor in the product will detect the difference and the product may start operating at Speed 2 or 3 depending on the difference. In this case, automatic mode will be turned off when the temperature difference is equalized.

 Do not use automatic mode when your hob is not working.

### **Air cleaning mode (for models B and C)**

You can use air cleaning mode to eliminate the odour in your house during a long time at low level.

- a. Touch the Speed 1 key for more than 3 seconds.
  - ⇒ Air cleaning mode is activated. The light of the Speed 1 key flashes when the air cleaning mode is active.
- b. The air cleaning mode will operate at Speed 1 for 10 minutes in 1 hour and will stop for 50 minutes. If you do not switch off the air cleaning mode, it will remain in operation for 10 minutes, then stop for 50 minutes in each hour for 24 hours.

 When air cleaning mode is active, it is automatically cancelled at the touch of any key except lamp key. Your hood continues to operate at the function of the key you touch.

### **Aluminium filter fill warning**

The light of Speed 2 key flashes after every 100 hours of operation. In this case, you must clean your aluminium filter. After cleaning, the lamp warning of Speed 2 button does not turn off automatically. When you touch the Speed 2 key for more than 3 seconds, aluminium filter fill warning is reset and the lamp is turned off.

 The warning is not cancelled if the power is cut when the hood gives aluminium filter fill warning. When power is available, it continues to warn with the light of Speed 2 key flashing.

 If you run your hood at any speed level with the aluminium filter fill warning, the warning will not appear for as long as the hood is running. When you turn off the hood, the fill warning starts flashing again.

 If you turn off the warning without cleaning the aluminium filter, the operating time of 100 hours is reset and it starts over. At the end of the next 100 hours, your hood warns again.

### **Carbon filter fill warning (for products with carbon filter)**

The light of Speed 2 key flashes after every 100 hours of operation. In this case, you must replace your carbon filter. Consult an authorized service for this. After replacement, the lamp warning of Speed 2 key does not turn off automatically. When you touch the Speed 2 button for more than 3 seconds, carbon filter fill warning is reset and the lamp is turned off.

 The warning is not cancelled if the power is cut when the hood gives carbon filter fill warning. When power is available, it continues to warn with the light of Speed 2 key flashing.

 If you run your hood at any speed level with the carbon filter fill warning, the warning will not appear for as long as the hood is running. When you turn off the hood, the fill warning starts flashing again.



If you turn off the warning without replacing the carbon filter, the operating time of 100 hours is reset and it starts over. At the end of the next 100 hours, warning is given again.

## 5 Maintenance and Cleaning

### 5.1 General Cleaning Information

#### General warnings

- Service life of the product extends and frequently faced problems decrease if cleaned at regular intervals.
- Disconnect the product from the electrical connection before starting maintenance and cleaning operations. There is an electric shock hazard!
- Some detergents or cleaning agents may cause damage to the surface. Do not use abrasive detergents, cleaning powders, cleaning creams or sharp objects during cleaning.
- Do not use steam cleaning products for cleaning.

#### Product cleaning

- The product should be thoroughly cleaned after each use. Thus, food residues are easily cleaned and these residues are prevented from burning when the product is used again later.
- No special cleaning agent is required for cleaning the product. Clean the product using dishwashing detergent, warm water and a soft cloth or sponge and dry it with a dry cloth.
- Do not use acid or chlorine-containing cleaning agents to clean stainless or inox surfaces and handles. Clean with a soft soapy cloth and liquid (non-scratching) detergent, taking care to wipe in one direction.
- There are sensors in the backside of the product's glass cover. Do not damage these sensors during cleaning. (For model C)

### 5.2 Aluminium Filter

This filter serves to retain oil particles in the air. **It is recommended to clean the filter once a month under normal usage.** To achieve this:

- a. Remove the aluminium filters.
- b. Wash the filters in water using liquid detergent and reinstall after drying.

Aluminium filters may change colour as they are washed; this is normal and does not require replacing your filters.



You can also wash the aluminium filter in the washing machine. (max. 70 °C)

#### Removing aluminium filters

- a. Open hood cover upwards and pull aluminium filter lock downwards as shown in the figure.

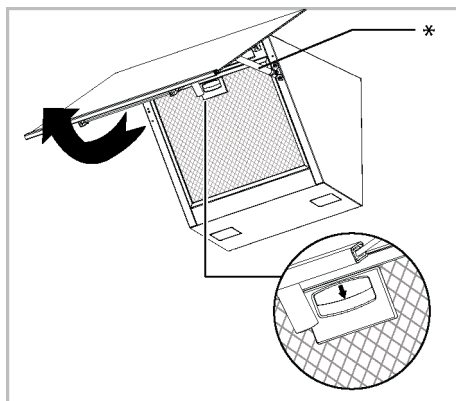

\* Silencer is optional. It may not be available on your product.

- b. Gently pull the filter towards you first and pull it upwards to remove it from its slot.



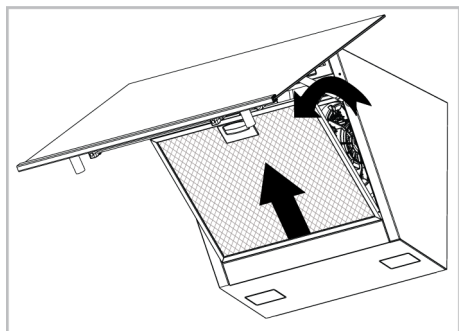

- c. Reinstall the aluminium filter in its slot after flushing by following the above steps in reverse.

### 5.3 Hood Lamp

In the event of a lamp malfunction in the hood, contact your local dealer or the Customer Service, and ensure that the lamp is replaced.

### 5.4 Carbon Filter (Usage without a flue)

#### General warnings

- If you have installed your product without a flue, you should replace your carbon filters every 4 months in normal use. You can obtain the carbon filter from Authorized Services.
- The carbon filter should never be washed.
- If you do not follow the rules for cleaning and replacing the filters of your hood, you may cause a fire.

## 6 Troubleshooting

If the problem persists after following the instructions in this section, contact your vendor or an Authorized Service. Never try to repair your product yourself.

#### Product is not working.

- Fuse may be faulty or blown. >>> Check the fuses in the fuse box. Change them if necessary or reactivate them.
- The product may not be plugged in. >>> Check if the product is plugged in to the outlet or not.
- The speed button may not be set. >>> Press/touch the desired speed button.

#### Removing carbon filters

- Open the glass cover of the hood and remove the aluminium filter.
- Unscrew the carbon filters on the right and left of the motor holder.

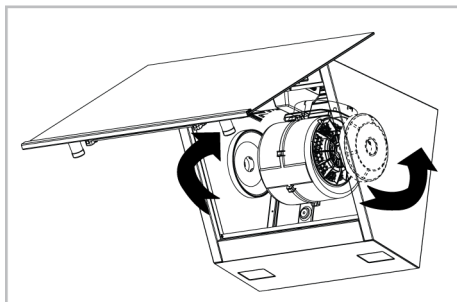

- Place the lug slots of your new carbon filters into the lugs on the motor holder and turn them clockwise to snap them into place.

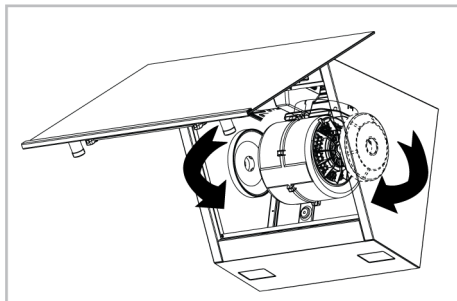

- Close the hood glass cover after installing the aluminium filter.

- No electricity. >>> Ensure the mains is operational and check the fuses in the fuse box. Change the fuses if necessary or reactivate them.

#### Hood light is not on.

- Hood lamp may be faulty. >>> Contact your local dealer where you purchased your product or the Customer Service, and ensure that the lamp is replaced.
- No electricity. >>> Ensure the mains is operational and check the fuses in the fuse box. Change the fuses if necessary or reactivate them.

## **GRUNDIG UK AND IRELAND STANDARD MANUFACTURER GUARANTEE TERMS AND CONDITIONS**

Your new Grundig product is guaranteed against faulty materials, defective components or manufacturing defects.

The standard guarantee starts from the date of original purchase of the product, and lasts for a period of thirty six (36) months unless Beko plc (the “Manufacturer”) agrees to extend the guarantee for the product in writing.

If you have registered the product within 90 days of purchase by completing the online registration form, then the standard 36 month guarantee will be extended to 60 months, under the same terms and conditions as detailed below

If you have any questions about the guarantee on your product (including how long it is valid), please contact your retailer or our contact centre on 0333 207 9920 (UK and Northern Ireland) or 01 691 0203 (Republic of Ireland)

This guarantee does not in any way diminish or affect your statutory rights in connection with the product. This guarantee is in addition to your statutory rights as a consumer. If you have any questions about these rights, please contact the retailer from which you purchased the product. In certain circumstances, it is possible that your statutory rights may offer additional or higher levels of protection than those offered under the terms of this guarantee.

### **What is covered by this guarantee?**

- Repairs to the product required as a result of faulty materials, defective components or manufacturing defects.
- Functional replacement parts to repair a product.
- The costs of a Grundig Approved Engineer to carry out the repair.

### **What is not covered?**

- Transit and delivery damage.
- Cabinet or appearance parts, including but not limited to control knobs, flaps and handles.
- Accessories and/or consumable items including but not limited to ice trays, scrapers, cutlery baskets, filters and light bulbs.
- Repairs necessary as a direct or indirect result of:
  - Accidental damage, misuse or abuse of a product.
  - An attempted repair of a product by anyone other than a Grundig Approved Engineer (the “Engineer”).
  - Installation or use of a product where such installation or use fails to meet the requirements contained in this guarantee or the User Instructions Booklet.
- Repairs to a product operated at any time on commercial or non-residential household premises (unless we have previously agreed to the installation environment).

This guarantee is limited to the cost of repairing the product. To the extent permitted by law, the Manufacturer does not accept and will not be held liable for any financial loss incurred in connection with the failure of any product to operate in accordance with the expected standards. Such financial loss includes but is not limited to loss arising from:

- Time taken off work.
- Damaged food, clothing or other items.
- Meals taken at restaurants or from takeaways.
- General compensation for inconvenience.

### **Important Notes**

1. Your product is designed and built for domestic household use only.
2. The guarantee will automatically be void if the product is installed or is used in commercial or non-residential domestic household premises, unless we have previously agreed to the installation environment.
3. The product must be correctly installed, located and operated in accordance with the instructions contained in the User Instructions Booklet provided with your product.
4. Professional installation by a qualified Electrical Domestic Appliance Installer is recommended for all Washing Machines, Dishwashers and Electric Cookers (as incorrect installation may result in you having to pay for the cost of repairing the product).
5. Gas Cookers must be professionally installed by a Gas Safe (or Gas Networks Ireland for Republic of Ireland) registered gas installer.
6. This guarantee is given in respect of products purchased and used within the United Kingdom and the Republic of Ireland.
7. This guarantee is effective from the initial date of purchase of a new product from an authorised retailer and will be void if the product is resold.
8. This guarantee does not apply to graded sales (where the product is purchased as a “second”).
9. Possession of a copy of these terms and conditions does not necessarily mean that a product has the benefit of this guarantee. If you have any questions, please call our Call Centre on the number set out above.
10. The Manufacturer reserves the right to terminate the guarantee if its staff or representatives are subjected to physical or verbal abuse in the course of carrying out their duties.
11. Optional extras, where available (i.e. extendable feet) are supplied on a chargeable basis only.

## **Does Grundig offer replacements?**

This is a repair-only guarantee. On occasion, the Manufacturer may at its sole discretion, replace your product with a new product instead of carrying out a repair. Where a replacement is offered, this would normally be an identical model but when this is not possible, a model of similar specification will be provided. The Manufacturer will cover the costs and arrange for the delivery of the new product and for the return of the old product. Any costs related to disconnecting the faulty product and installing the replacement product will not be borne by the Manufacturer unless previously agreed to in writing. The original guarantee will continue to apply to the replacement product; the new product will not come with a new guarantee.

## **When will the repair take place?**

Our Engineers work Monday to Friday 9.00am to 5.00pm. Appointments outside these hours may be possible at the sole discretion of the Manufacturer but cannot be guaranteed. Whilst our Engineers will endeavour to minimize inconvenience and to meet requests for specific timed appointments, this cannot be guaranteed. We will not be liable for delays or if it is unable to carry out a repair because a convenient appointment cannot be arranged.

## **Will there be any charge for the repairs?**

It is your responsibility to provide evidence to the Engineer that your product is covered by this guarantee with a proof of purchase. The Manufacturer reserves the right to charge for the reasonable cost of any service call if:

- You cannot provide evidence that your product is covered by this guarantee.
- Where a service call has been made and the engineer finds that there is no fault with your product.
- That your product has not been installed or operated in accordance with the User Instructions Booklet.
- That the fault was caused by something other than faulty materials, defective components or manufacturing defects.
- For missed appointments.

Payment of these costs are due immediately upon the Engineer providing you with an invoice. The Manufacturer reserves the right to terminate the guarantee if you fail to pay the costs for the service call in a timely manner.

If you are a resident of the United Kingdom, this guarantee will be governed by English law and subject to the English Courts, save where you live in another part of the United Kingdom, in which case the law and courts of that location will apply.

If you are resident in the Republic of Ireland, this guarantee will be governed by Irish law and the Irish courts will have jurisdiction.

This guarantee is provided by Beko plc. Beko House, 1 Greenhill Crescent, Watford, Hertfordshire. WD18 8QU.

Beko plc is registered in England and Wales with company registration number 02415578.

## **GRUNDIG UK AND IRELAND ECO INVERTER MOTOR GUARANTEE TERMS AND CONDITIONS**

This 10 year guarantee relates to Grundig products that feature the Eco Inverter Motor.

The Eco Inverter Motor guarantee terms and conditions are in addition to our Standard guarantee terms and conditions detailed in the previous section.

**In order to activate the 10 year guarantee you MUST register the appliance within 90 days of the original purchase date. You can register by first visiting [grundig.co.uk/register](http://grundig.co.uk/register) and by following the online instructions.**

Grundig Free standing and Built-in appliances come with a 36 month parts and labour guarantee as standard, which can be extended to a 60 months parts and labour guarantee by registering within 90 days of the original purchase date.

To make a claim against your Grundig Eco Inverter Motor Guarantee (the "Guarantee"), all customer and product details must be registered with Beko plc using the procedure outlined below.

1. This extra 7 years (or 5 years for appliances registered within 90 days of the original purchase date) Guarantee is only effective after the expiration of the standard manufacturer's guarantee.
2. It is only valid for the Eco Inverter motors of selected washing machines, washer-dryers, tumble dryers and dishwashers. It does not cover any labour charge or any other components of the product. In addition, it is only valid for one replacement of the Eco Inverter motor during the extra 7 years (or 5 years for appliances registered within 90 days of the original purchase date) guarantee period.
3. To activate your guarantee, you MUST register your appliance within 90 days of the original purchase date, by visiting [grundig.co.uk/register](http://grundig.co.uk/register).
4. Customers will receive a unique reference code as proof of guarantee validation by email or post, which must be quoted at the time of a claim being made.
5. Any repair/replacement of the Eco Inverter motor must only be carried out by an authorised Grundig Service Agent (the "Service Agent").
6. Labour for the repair/replacement of the Eco Inverter motor is not included in this guarantee and is chargeable directly by the Service Agent.
7. Any additional components fitted to the product at any time will not be covered by this guarantee and will be chargeable directly by the Service Agent.
8. The guarantee is not transferable and cannot be exchanged for cash.
9. There are no alternative or additional offers to this Guarantee.

10. The guarantee is exclusive of the manufacturer's standard guarantee
11. The Terms and Conditions shown above are in addition to the standard terms and conditions of your product guarantee. Please read and refer to such Terms and Conditions when making any claim.
12. We may use the information you provide for marketing purposes and to analyse your purchasing preferences. We may keep your information for a reasonable period for these purposes in accordance with the applicable Data Protection Laws and General Data Protection Regulations (GDPR). You can opt into this service during the registration process. Further details are available at <http://www.Grundig.co.uk/cookie-and-privacy>.
13. These Terms and Conditions are governed by the laws of England and Wales; manufacturer: Beko plc, Beko House, 1 Greenhill Crescent, Watford WD18 8QU. Company Registration Number: 02415578.

## HOW TO OBTAIN SERVICE FOR YOUR APPLIANCE

Please keep your purchase receipt or other proof of purchase details in a safe place; you will need to have this documentation available should the product require attention under guarantee.

Please take a few moments to complete the details below, as you will need this information when you call us, or to use our online services. When you call us you may be required to input your serial number into your telephone keypad. For help please visit [grundig.co.uk/support/model-finder](http://grundig.co.uk/support/model-finder)

- The product model number is printed on the Operating Instruction Booklet / User guide
- The product model and serial number is printed on the Rating Label affixed to the appliance.
- The Retailer (Purchased from) and Date of purchase will be printed on your purchase receipt or other proof of purchase paperwork

Recording of these details alone will not count as proof of purchase. A valid proof of purchase is required for requesting service under guarantee.

Model number	Serial number	Purchased from	Date of purchase

### **For service under guarantee or for product advice please call our Contact centre**

Before requesting service please check the troubleshooting guide in the Operating Instructions booklet, as a charge may be levied where no fault is found, and even though your product may still be under guarantee.

After arranging service the area around the product must be easily accessible to the Engineer, without the need for cabinets or furniture to be removed or moved.

It is your responsibility to ensure our Engineers have a clean and safe environment to carry out any repairs.

Please have your Model number and Serial number available when you call us, as you may be required to input your serial number into your telephone keypad during your call.

### **UK Mainland & Northern Ireland:**

# 0333 207 9920

Landline or mobile calls to 0333 numbers cost no more than calls to geographic numbers 01 or 02, and are charged at the basic rate. Calls from landlines and mobiles are included in free call packages but please check with your telephone service provider for exact call charges.

**Republic of Ireland:**

**01 691 0203**

**Service once the manufacturers guarantee has expired**

*If you have purchased an extended guarantee please refer to the instructions contained within the extended guarantee agreement document, otherwise please call us using the appropriate number above, where service can be obtained at a charge.*

Should you experience any difficulty in obtaining service please call us on 0333 207 9920 or 01 691 0203

**Contact us though our website**

Send us a secure message through our online contact us form. Please visit our website, click Contact Us and choose a product support topic from the list of options. Complete the required details and click send message.

**Product registrations**

For UK and Republic of Ireland product registrations please visit [grundig.co.uk/register](http://grundig.co.uk/register).